

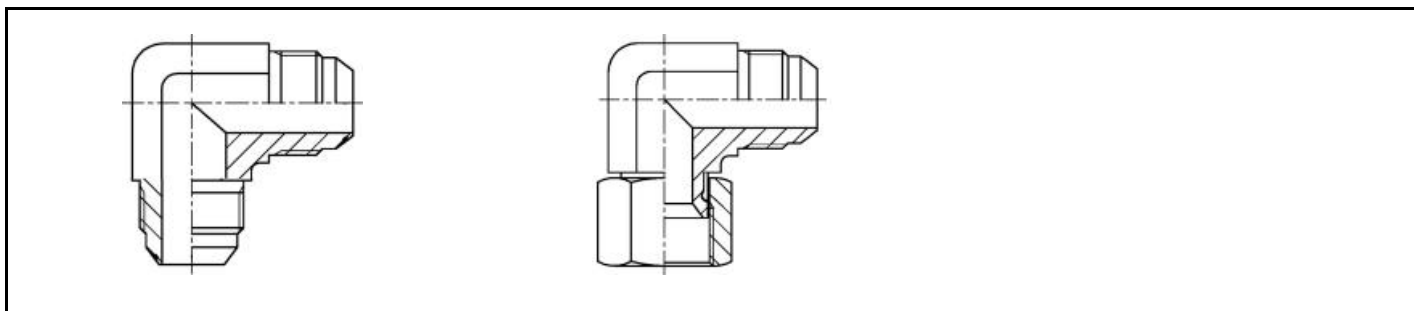

OLEODINAMICA

Gomito intermedio











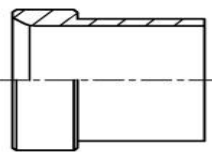
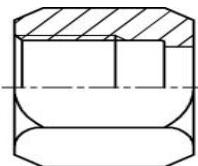

Informazioni**Serie JC**

Sottotitolo	In acciaio al carbonio (fornibile a richiesta serie "JI" in acciaio INOX)
--------------------	---

Tabella codici

Codice Fornitore	Ø tubo ([mm])
JC2504	12
JC2505	14/15/16
JC2506	18/20
JC2507	25
JC2508	30/32
JC2509	38
JC2503	10
JC2502	8
JC2501	6

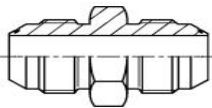
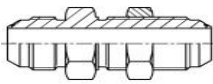
PRODOTTI DELLA STESSA SERIE

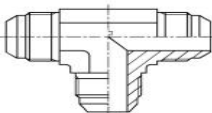
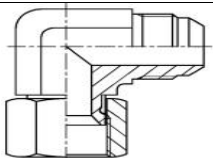
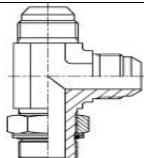
		
BUSSOLA DI SERRAGGIO	DADO DI SERRAGGIO	DIRITTO DI ESTREMITÀ
		
DIRITTO DI ESTREMITÀ	DIRITTO DI ESTREMITÀ FEMMINA	DIRITTO DI ESTREMITÀ
		
DIRITTO DI ESTREMITÀ	GOMITO DI ESTREMITÀ	GOMITO DI ESTREMITÀ
		
DIRITTO INTERMEDIO	DIRITTO DI ATTRAVERSAMENTO INTERMEDIO	DIRITTO DI ESTREMITÀ CON DADO GIREVOLE
		
"T" INTERMEDIO	GOMITO ORIENTABILE CON DADO	"T" ORIENTABILE CON DADO GIREVOLE

GIREVOLE



GOMITO DI ESTREMITÀ ORIENTABILE

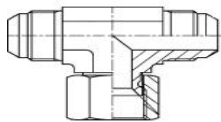

"T" ORIENTABILE CON DADO GIREVOLE

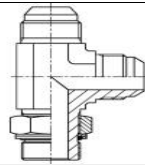

"T" DI ESTREMITÀ LATERALE ORIENTABILE



"T" DI ESTREMITÀ CENTRALE ORIENTABILE

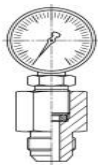

PORTAMANOMETRO

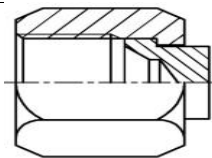

TAPPO FEMMINA PER CHIUSURA RACCORDO

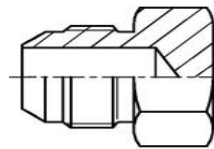

TAPPO MASCHIO PER CHIUSURA TUBO

Documenti

Nessun documento