

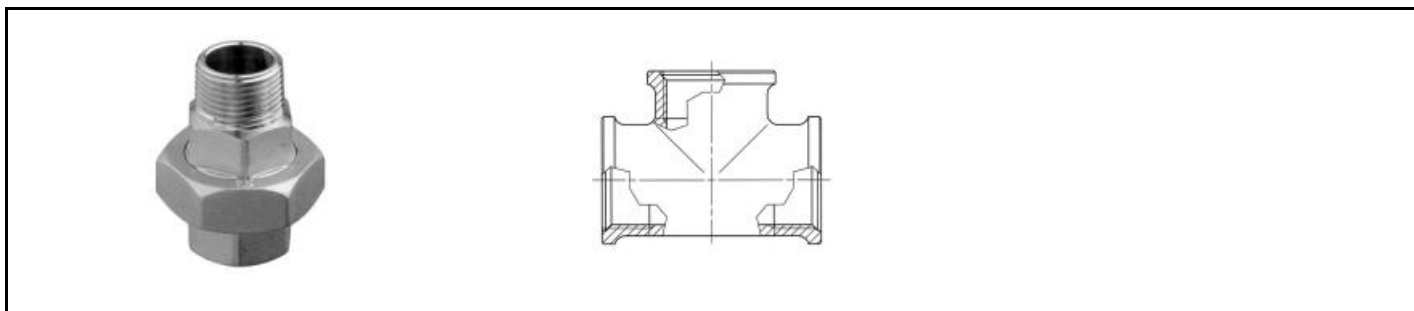

Bocchettone 3 pezzi M-F diritto



**Informazioni****Serie HL-HP**

|                    |   |
|--------------------|---|
| <b>Materiale</b>   | Ottone nichelato (Ottone grezzo dove espressamente indicato)                              |
| <b>Filettature</b> | Maschio conico: Gas ISO 7/1 Maschio cilindrico: Gas ISO 228 Femmina: Gas ISO 228          |
| <b>Pressione</b>   | 10 bar (pressioni maggiori sono possibili in base al tipo di raccordo e di utilizzo)      |
| <b>Temperatura</b> | max 110°C (a temperature maggiori le pressioni di utilizzo subiscono un calo progressivo) |

**Bocchettone 3 pezzi M-F diritto**















•

Sottotitolo con O-Ring NBR (Ottone nichelato)

Tabella codici

| Codice Fornitore | Misura | Modello |
|------------------|--------|---------|
| HPN-341 1/2      | 1/2"   | HPN-341 |
| HPN-341 3/4      | 3/4"   | HPN-341 |
| HPN-341 1"       | 1"     | HPN-341 |
| HPN-341 1"1/4    | 1"1/4  | HPN-341 |
| HPN-341 1"1/2    | 1"1/2  | HPN-341 |
| HPN-341 2"       | 2"     | HPN-341 |

PRODOTTI DELLA STESSA SERIE

|   |   |   |
|---|---|---|
|    |    |    |
| NIPPLO CONICO   | NIPPLO CILINDRICO   | NIPPLO DI RIDUZIONE CONICO  |
|   |   |   |
| NIPPLO DI RIDUZIONE CILINDRICO  | RIDUZIONE M-F CONICA  | RIDUZIONE M-F CILINDRICA  |
|  |  |  |
| MANICOTTO F-F   | GOMITO F-F  | GOMITO LARGO F-F  |
|  |  |  |
| GOMITO M-F CONICO   | GOMITO LARGO M-F CONICO   | T F-F-F   |
|  |  |  |
| TAPPO MASCHIO CONICO CON QUADRO   | PORTAGOMMA MASCHIO CILINDRICO   | PORTAGOMMA MASCHIO CILINDRICO   |



PORTAGOMMA MASCHIO CILINDRICO



BOCCHETTONE 3 PEZZI M-F A GOMITO



BOCCHETTONE 3 PEZZI M-F DIRITTO



BOCCHETTONE 3 PEZZI M-M DIRITTO



BOCCHETTONE 3 PEZZI M-M DIRITTO



BOCCHETTONE 3 PEZZI F-F DIRITTO

BOCCHETTONE 3 PEZZI M-  
PORTAGOMMA DIRITTOBOCCHETTONE 3 PEZZI M-  
PORTAGOMMA A GOMITO

---

Documenti

Nessun documento