

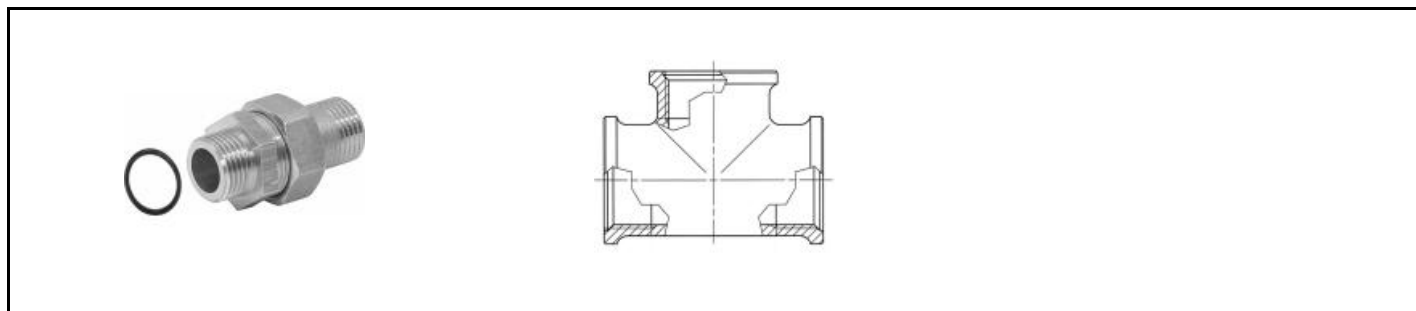

Bocchettone 3 pezzi M-M diritto



Informazioni**Serie HL-HP**

Materiale	Ottone nichelato (Ottone grezzo dove espressamente indicato)
Filettature	Maschio conico: Gas ISO 7/1 Maschio cilindrico: Gas ISO 228 Femmina: Gas ISO 228
Pressione	10 bar (pressioni maggiori sono possibili in base al tipo di raccordo e di utilizzo)
Temperatura	max 110°C (a temperature maggiori le pressioni di utilizzo subiscono un calo progressivo)

Bocchettone 3 pezzi M-M diritto

•















Sottotitolo

con O-ring (Ottone grezzo)

Tabella codici

Codice Fornitore	Misura	Modello
HLG-127 3/8	3/8"	HLG-127
HLG-127 1/2	1/2"	HLG-127
HLG-127 3/4	3/4"	HLG-127
HLG-127 1"	1"	HLG-127
HLG-127 1"1/4	1" 1/4	HLG-127

PRODOTTI DELLA STESSA SERIE

		
NIPPLO CONICO	NIPPLO CILINDRICO	NIPPLO DI RIDUZIONE CONICO
		
NIPPLO DI RIDUZIONE CILINDRICO	RIDUZIONE M-F CONICA	RIDUZIONE M-F CILINDRICA
		
MANICOTTO F-F	GOMITO F-F	GOMITO LARGO F-F
		
GOMITO M-F CONICO	GOMITO LARGO M-F CONICO	T F-F-F
		
TAPPO MASCHIO CONICO CON QUADRO	PORTAGOMMA MASCHIO CILINDRICO	PORTAGOMMA MASCHIO CILINDRICO



PORTAGOMMA MASCHIO CILINDRICO



BOCCHETTONE 3 PEZZI M-F A GOMITO



BOCCHETTONE 3 PEZZI M-F DIRITTO



BOCCHETTONE 3 PEZZI M-M DIRITTO



BOCCHETTONE 3 PEZZI F-F DIRITTO



BOCCHETTONE 3 PEZZI M-F DIRITTO



BOCCHETTONE 3 PEZZI M-PORTAGOMMA DIRITTO



BOCCHETTONE 3 PEZZI M-PORTAGOMMA A GOMITO

Documenti

Nessun documento