

**PNEUMATICA****FLUIDICA**

Tappo maschio conico con quadro

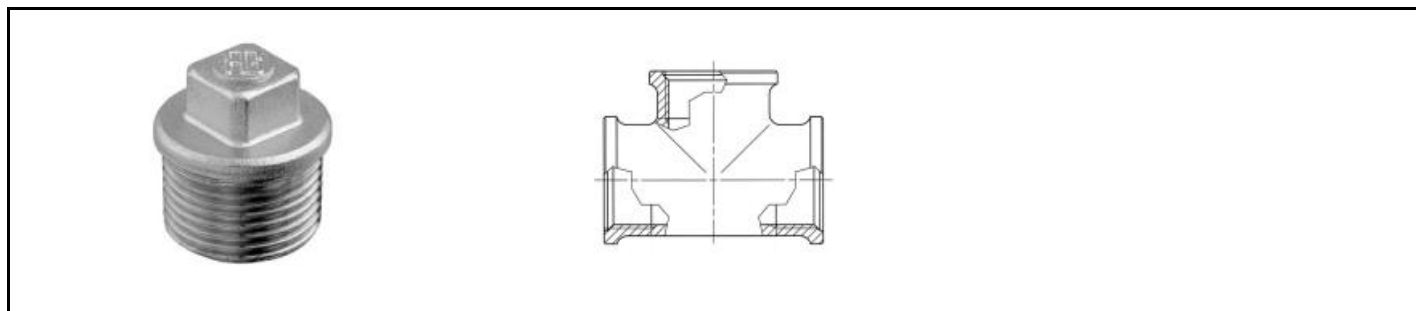















Informazioni**Serie HL-HP**

Materiale	Ottone nichelato (Ottone grezzo dove espressamente indicato)
Filettature	Maschio conico: Gas ISO 7/1 Maschio cilindrico: Gas ISO 228 Femmina: Gas ISO 228
Pressione	10 bar (pressioni maggiori sono possibili in base al tipo di raccordo e di utilizzo)
Temperatura	max 110°C (a temperature maggiori le pressioni di utilizzo subiscono un calo progressivo)

Tabella codici

Codice Fornitore	Misura	Modello
HPN-290 1/4	1/4"	HPN-290
HPN-290 3/8	3/8"	HPN-290
HPN-290 1/2	1/2"	HPN-290
HPN-290 3/4	3/4"	HPN-290
HPN-290 1"	1"	HPN-290
HPN-290 1"1/4	1"1/4	HPN-290
HPN-290 1"1/2	1"1/2	HPN-290
HPN-290 2"	2"	HPN-290

PRODOTTI DELLA STESSA SERIE

		
NIPPLO CONICO	NIPPLO CILINDRICO	NIPPLO DI RIDUZIONE CONICO
		
NIPPLO DI RIDUZIONE CILINDRICO	RIDUZIONE M-F CONICA	RIDUZIONE M-F CILINDRICA
		
MANICOTTO F-F	GOMITO F-F	GOMITO LARGO F-F
		
GOMITO M-F CONICO	GOMITO LARGO M-F CONICO	T F-F-F
		
PORTAGOMMA MASCHIO CILINDRICO	PORTAGOMMA MASCHIO CILINDRICO	PORTAGOMMA MASCHIO CILINDRICO



BOCCHETTONE 3 PEZZI M-F A GOMITO



BOCCHETTONE 3 PEZZI M-F DIRITTO



BOCCHETTONE 3 PEZZI M-M DIRITTO



BOCCHETTONE 3 PEZZI M-M DIRITTO



BOCCHETTONE 3 PEZZI F-F DIRITTO



BOCCHETTONE 3 PEZZI M-F DIRITTO

BOCCHETTONE 3 PEZZI M-
PORTAGOMMA DIRITTOBOCCHETTONE 3 PEZZI M-
PORTAGOMMA A GOMITO

Documenti

Nessun documento