

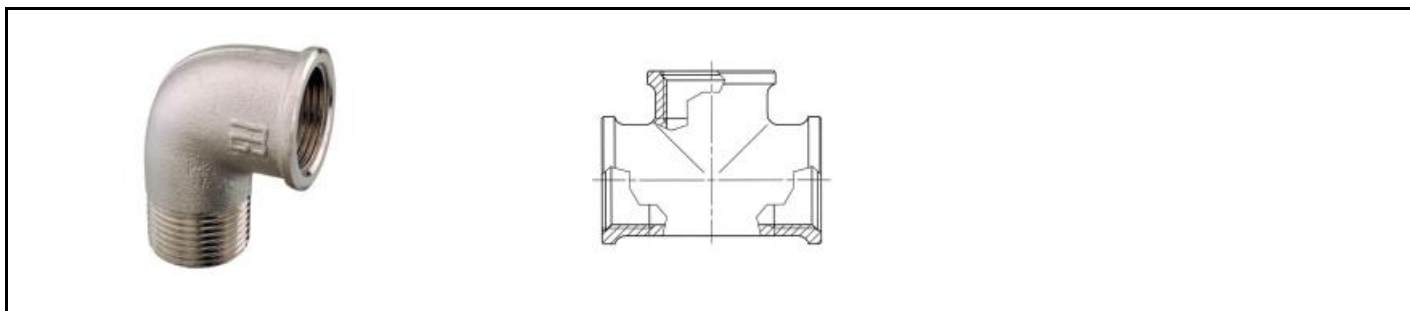

Gomito M-F conico

















**Informazioni****Serie HL-HP**

<b>Materiale</b>	Ottone nichelato (Ottone grezzo dove espressamente indicato)
<b>Filettature</b>	Maschio conico: Gas ISO 7/1 Maschio cilindrico: Gas ISO 228 Femmina: Gas ISO 228
<b>Pressione</b>	10 bar (pressioni maggiori sono possibili in base al tipo di raccordo e di utilizzo)
<b>Temperatura</b>	max 110°C (a temperature maggiori le pressioni di utilizzo subiscono un calo progressivo)

Tabella codici

Codice Fornitore	Misura	Modello
HPN-92 2"	2"	HPN-92
HPN-92 1"1/2	1"1/2	HPN-92
HPN-92 1"1/4	1"1/4	HPN-92
HPN-92 1"	1"	HPN-92
HPN-92 3/4	3/4"	HPN-92
HPN-92 1/2	1/2"	HPN-92

PRODOTTI DELLA STESSA SERIE

		
NIPPLO CONICO	NIPPLO CILINDRICO	NIPPLO DI RIDUZIONE CONICO
		
NIPPLO DI RIDUZIONE CILINDRICO	RIDUZIONE M-F CONICA	RIDUZIONE M-F CILINDRICA
		
MANICOTTO F-F	GOMITO F-F	GOMITO LARGO F-F
		
GOMITO LARGO M-F CONICO	T F-F-F	TAPPO MASCHIO CONICO CON QUADRO
		
PORTAGOMMA MASCHIO CILINDRICO	PORTAGOMMA MASCHIO CILINDRICO	PORTAGOMMA MASCHIO CILINDRICO



BOCCHETTONE 3 PEZZI M-F A GOMITO



BOCCHETTONE 3 PEZZI M-F DIRITTO



BOCCHETTONE 3 PEZZI M-M DIRITTO



BOCCHETTONE 3 PEZZI M-M DIRITTO



BOCCHETTONE 3 PEZZI F-F DIRITTO



BOCCHETTONE 3 PEZZI M-F DIRITTO



BOCCHETTONE 3 PEZZI M-  
PORTAGOMMA DIRITTO



BOCCHETTONE 3 PEZZI M-  
PORTAGOMMA A GOMITO

---

Documenti

Nessun documento