

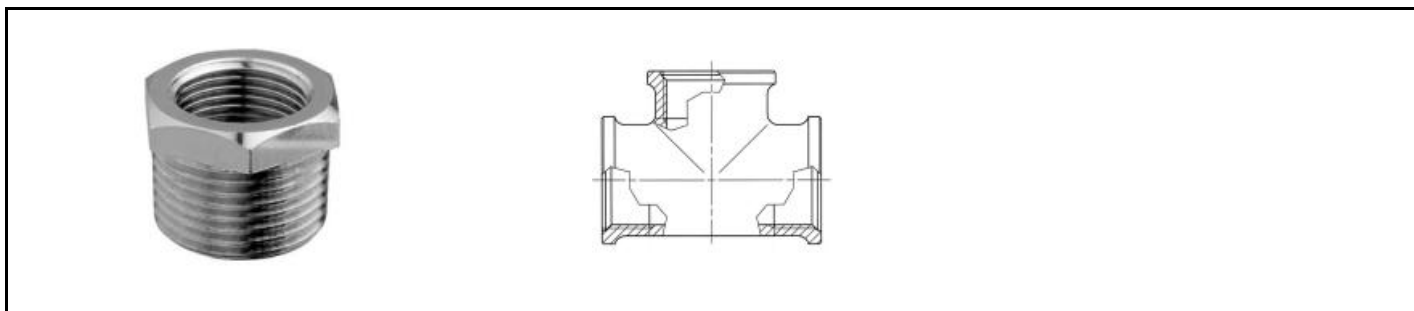

Riduzione M-F conica



**Informazioni****Serie HL-HP**



<b>Materiale</b>	Ottone nichelato (Ottone grezzo dove espressamente indicato)
<b>Filettature</b>	Maschio conico: Gas ISO 7/1 Maschio cilindrico: Gas ISO 228 Femmina: Gas ISO 228
<b>Pressione</b>	10 bar (pressioni maggiori sono possibili in base al tipo di raccordo e di utilizzo)
<b>Temperatura</b>	max 110°C (a temperature maggiori le pressioni di utilizzo subiscono un calo progressivo)

Tabella codici

Codice Fornitore	Misura MF	Modello
HPN-241 1"-3/4"	1"-3/4"	HPN-241
HPN-241 3/4"-3/8"	3/4"-3/8"	HPN-241
HPN-241 1"-1/2"	1"-1/2"	HPN-241
HPN-241 3/4"-1/4"	3/4"-1/4"	HPN-241
HPN-241 2"-1"1/2"	2"-1"1/2"	HPN-241
HPN-241 2"-1"1/4"	2"-1"1/4"	HPN-241
HPN-241 2"-1"	2"-1"	HPN-241
HPN-241 1"1/2"-1"1/4"	1"1/2"-1"1/4"	HPN-241
HPN-241 1"1/2"-1"	1"1/2"-1"	HPN-241
HPN-241 1"1/4"-1"	1"1/4"-1"	HPN-241
HPN-241 1"1/4"-3/4"	1"1/4"-3/4"	HPN-241

PRODOTTI DELLA STESSA SERIE







		
NIPPLO CONICO	NIPPLO CILINDRICO	NIPPLO DI RIDUZIONE CONICO

		
NIPPLO DI RIDUZIONE CILINDRICO	RIDUZIONE M-F CILINDRICA	MANICOTTO F-F

		
GOMITO F-F	GOMITO LARGO F-F	GOMITO M-F CONICO

		
GOMITO LARGO M-F CONICO	T F-F-F	TAPPO MASCHIO CONICO CON QUADRO

		
---	---	---

<p>PORTAGOMMA MASCHIO CILINDRICO</p>	<p>PORTAGOMMA MASCHIO CILINDRICO</p>	<p>PORTAGOMMA MASCHIO CILINDRICO</p>
		
<p>BOCCHETTONE 3 PEZZI M-F A GOMITO</p>	<p>BOCCHETTONE 3 PEZZI M-F DIRITTO</p>	<p>BOCCHETTONE 3 PEZZI M-M DIRITTO</p>
		
<p>BOCCHETTONE 3 PEZZI M-M DIRITTO</p>	<p>BOCCHETTONE 3 PEZZI F-F DIRITTO</p>	<p>BOCCHETTONE 3 PEZZI M-F DIRITTO</p>
		
<p>BOCCHETTONE 3 PEZZI M-PORTAGOMMA DIRITTO</p>	<p>BOCCHETTONE 3 PEZZI M-PORTAGOMMA A GOMITO</p>	

---

Documenti

Nessun documento