

**Nipplo di riduzione conico**

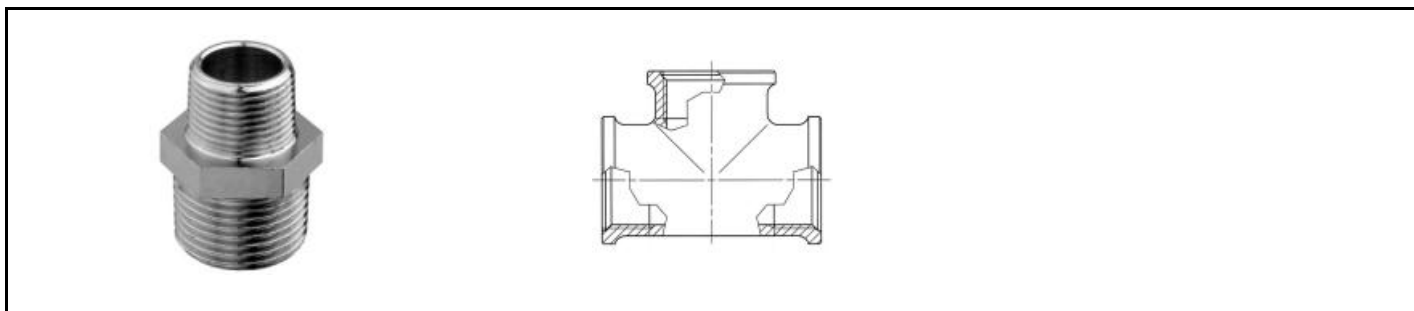













Informazioni**Serie HL-HP**

Materiale	Ottone nichelato (Ottone grezzo dove espressamente indicato)
Filettature	Maschio conico: Gas ISO 7/1 Maschio cilindrico: Gas ISO 228 Femmina: Gas ISO 228
Pressione	10 bar (pressioni maggiori sono possibili in base al tipo di raccordo e di utilizzo)
Temperatura	max 110°C (a temperature maggiori le pressioni di utilizzo subiscono un calo progressivo)

Tabella codici

Codice Fornitore	Misura MM	Modello
HPN-245 2"1/2-2"	2"1/2-2"	HPN-245
HPN-245 2"-1"1/2	2"-1"1/2	HPN-245
HPN-245 1"1/2-1"1/4	1"1/2-1"1/4	HPN-245
HPN-245 1"1/4-1"	1"1/4-1"	HPN-245
HPN-245 1"-3/4	1"-3/4"	HPN-245
HPN-245 1"-1/2	1"-1/2"	HPN-245

PRODOTTI DELLA STESSA SERIE

		
NIPPLO CONICO	NIPPLO CILINDRICO	NIPPLO DI RIDUZIONE CILINDRICO
		
RIDUZIONE M-F CONICA	RIDUZIONE M-F CILINDRICA	MANICOTTO F-F
		
GOMITO F-F	GOMITO LARGO F-F	GOMITO M-F CONICO
		
GOMITO LARGO M-F CONICO	T F-F-F	TAPPO MASCHIO CONICO CON QUADRO
		
PORTAGOMMA MASCHIO CILINDRICO	PORTAGOMMA MASCHIO CILINDRICO	PORTAGOMMA MASCHIO CILINDRICO



BOCCHETTONE 3 PEZZI M-F A GOMITO



BOCCHETTONE 3 PEZZI M-F DIRITTO



BOCCHETTONE 3 PEZZI M-M DIRITTO



BOCCHETTONE 3 PEZZI M-M DIRITTO



BOCCHETTONE 3 PEZZI F-F DIRITTO



BOCCHETTONE 3 PEZZI M-F DIRITTO



BOCCHETTONE 3 PEZZI M-
PORTAGOMMA DIRITTO



BOCCHETTONE 3 PEZZI M-
PORTAGOMMA A GOMITO

Documenti

Nessun documento